

ALAN DENTAL™

Version:07/2019-C2  
Date of compilation: August 2021



VRN - Q5

Ultrasonic Scaler

---

# OPERATION MANUAL

# CONTENTS

Statement.....	2	3.6 Automatic water supply function and use .....	17
1 Product Overview.....	4	3.7 Operation precautions.....	17
1.1 Overview.....	4	4 Cleaning, disinfection and sterilization.....	19
1.2 Product Performance Structure and Composition.....	4	4.1 Disinfection of handpiece .....	19
1.3 Intended use.....	5	4.2 Disinfection of working tip.....	20
1.4 Contraindication .....	5	4.3 Disinfection of torque wrench and root canal wrench.....	20
1.5 Main technical parameters .....	5	4.4 Cleaning of working tip, torque wrench and root canal wrench.....	20
1.6 Operation environmental requirements.....	7	5 Troubleshooting.....	21
2 Product installation.....	8	6 Storage, maintenance, transportation.....	24
3 Product function and use .....	13	7 Maintenance List.....	25
3.1 Operating instructions for the use of the main components of the plug-in handpiece.....	13	8 After-sales ervice.....	27
3.2 Operating instructions of torque wrench.....	13	9 Graphic Sign.....	27
3.3 Tooth cleaning, periodontal function and use.....	14	10 Environment Protection.....	28
3.4 Root canal washing function and its application .....	16	11 Manufacturer's rights.....	29
3.5 Control function and use of wireless foot switch .....	16	12 Electromagnetic compatibility (EMC).....	29
		13 Attached able: Power Table of Working Tip . . .	36

## Statement

URIT MEDICAL ELECTRONIC CO., LTD. © ALL RIGHTS RESERVED

Congratulations on becoming a respected customer of URIT MEDICAL ELECTRONIC CO., LTD, and welcome to use the VRN-Q5 ultrasonic scaler, which will bring you a new experience and convenience. This User Manual is prepared in accordance with the laws and regulations of the People's Republic of China, and the specific conditions when the VRN-Q5 ultrasonic scaler is manufactured by URIT MEDICAL ELECTRONIC CO., LTD, it is only applicable to the VRN-Q5 ultrasonic scaler sold in the mainland of the People's Republic of China (excluding Taiwan, Hong Kong and Macao). This User Manual includes the latest information up to the time of its printing. URIT MEDICAL ELECTRONIC CO., LTD is solely responsible for the revision and interpretation of simplified Chinese version of this User Manual, and reserves the right to make alterations without notice after printing. Some pictures and schematic diagrams listed in this User Manual are for reference only. If the picture is inconsistent with the real object, the real object shall prevail.

All information stated in this User Manual is protected by copyright law. Without the prior written consent of URIT MEDICAL ELECTRONIC CO., LTD, the contents in the User Manual shall not be reproduced, copied or translated into other languages in any form.

The use of the product must comply with the requirements of relevant operating procedures and relevant regulations of the medical department, and can only be used by trained doctors or technicians.

In order to keep the handpiece in good working condition, it is necessary to maintain the handpiece regularly, and use the handpiece on the machine at least once a month, and keep it dry after use.

The tip of the wrench can be sterilized by high temperature and high pressure, refer to 4.1.

The product cannot be disassembled privately. If necessary, please disassemble and repair it under the authorization of the company. The repair is limited to the replacement of the tail line, main board, and water

pump.

The circuit diagrams, parts lists, instructions, calibration instructions and other information provided in the manual can be used by companies or individuals authorized by the company to repair the products.

Please carefully read this User Manual before use and properly keep it for future reference. All operations must be carried out in strict accordance with the operating instructions of this User Manual. Otherwise, URIT MEDICAL ELECTRONIC CO., LTD will not be responsible for any errors and product damage caused by illegal operation.



### Note:

URIT MEDICAL ELECTRONIC CO., LTD does not promise the products to be used for certain special purposes, or make any implied guarantee for their marketability and applicability.

If you need the support of after-sales service, please contact URIT MEDICAL ELECTRONIC CO., LTD or its authorized agent.

## 1. Product Overview

### 1.1 Overview

By employing the full-automatic frequency tracking system, the VRN-Q5 ultrasonic scaler is available to realize such functions as tooth scaling, periodontal treatment, endodontic irrigating, and automatic water supply; in addition, it has the following features:

- The internal liquid path is made of anti-bacteria material, and the liquids used in clinic, such as hydrogen peroxide solution, chlorhexidine, sodium hypochlorite, etc., are applicable to the mode of automatic water supply system, which can significantly improve the performance of periodontal treatment and endodontic irrigating.
- The handpiece can be sterilized under 135 °C high temperature and 0.22MP pressure.
- Automatic search for the best working state, the machine performance is more stable.
- This instrument is equipped with the built-in CPU, and could realize the smart control of tooth cleaning power, thus it is more comfortable during the process of tooth scaling;
- By employing the wireless foot switch to remotely control the operation of the main unit, the operation is more convenient, and the wired foot switch can be selected according to the needs of the user.
- Adopt high-brightness LED illumination, which not only improves the clinical operation efficiency, but also enables the commonly used detachable handpiece to have high compatibility.
- The use period is 10 years.

### 1.2 Product Performance Structure and Composition

The ultrasonic scaler is mainly composed of function control circuit, fluid path, handpiece, tip, Power Adapter and foot switch (wired or wireless).

### 1.3 Intended use

It is available to remove calculus, plaque and other dental stains on the surface of teeth, remove calculus and plaque in the periodontal pocket, and clean and wash the root canal of teeth.

Applicable people: people except for contraindications.

Place of use: professional dental clinics and hospitals.

### 1.4 Contraindication

- Approval of a suitably qualified medical practitioner should be sort prior to use with haemophiliacs, or pregnant women, or children.
- Ultrasonic oscillations may prevent cardiac pace makers and debrillators. From functioning properly. Therefore, we recommend that patients with a cardiac pace maker or a debrillator should not be treated with this product.
- Scaling generates an aerosol; patients with high-risk infectious diseases should not be treated as it may put others at risk.

### 1.5 Main technical parameters

- Input Voltage: 230VAC, 50 Hz
- Input power: 35VA
- Wireless foot switch battery: size AA battery × 2
- Receiving sensitivity -114 dB (in accordance with China National Telecommunication Law) Receiving frequency: 2.4GHz ISM band
- The recommended atmospheric pressure for the product is 70kPa ~ 106kPa, and the water pressure is 0.01Mpa ~ 0.5Mpa. Working state, air consumption is 0L/min, maximum water consumption is 50mL/min. Water bottle outlet pressure is 0.02Mpa.



- Main offset of instrument working tip due to vibration: minimum value, 1µm; deviation -50%  
maximum value, 100µm; deviation +50%
- Half offset force: Minimum value, 0.1 N; deviation -50%  
Maximum value, 2 N; deviation +50%
- Tip vibrating frequency: 25kHz~35kHz.

Note: The tip vibrating frequencies of different types of working tip are different, but all are distributed within the described range.

- Tip output power: 3W~20W.
- Fuse: T1AH 250V.
- Weight of main unit: 1.8 kg.
- Running mode: continuous running.
- Type of Electric-shock protection: Class I equipment.
- Level of electric shock protection: B type application part.
- Level of protection against incoming fluid: common equipment (IPX0), wired foot switch is waterproof equipment (IPX1), wireless foot switch is waterproof equipment (IPX4).
- Safety degree in the case of flammable anesthetic gas mixed with air or flammable anesthetic gas mixed with oxygen or nitrous oxide: Non-AP, APG type equipment.
- Wireless foot switch: transmission frequency: 2.412 GHz-2.462 GHz,, modulation type: GFSK, Max. radiation power: 12dBm.

#### **Radio Frequency Interface Requirements – Related to European installation**

- Note: This equipment has been tested and found to comply with the limits for a EN 300 440 v2.1.1

receiver Category 3.

- These limits are designed to provide reasonable protection against harmful interference in a residential installation.
- This equipment is sensitive to other equipment that intentionally generates, radio frequency energy in the 2402~2483.5MHz that may conduce to the instability to use the Remote Control on it. However there is no guarantee that interference will not occur in a particular installation. If this equipment suffer from the harmful interference from another radio device to radio this can be determined by turning the respective equipment off and on, the user is encouraged to try to correct the interference by one or more of the following measures:
  - Turn off the disturbance equipment
  - Increase the separation between the disturbance equipment
  - Consult the dealer or an experienced radio / TV technician for help.

#### 1.6 Working environment.

- a) Environmental temperature: 5°C~40°C
  - b) Relative humidity: =80%
  - c) Atmospheric pressure: 70kPa ~ 106kPa
  - d) Application range of power supply and voltage: 230VAC, 50Hz
  - e) The maximum inlet pressure of handpieces is 0.5mpa.
- See the specific specifications on the label.

## 2. Product installation

### 2.1. Main Unit Front & Rear Schematic Diagram

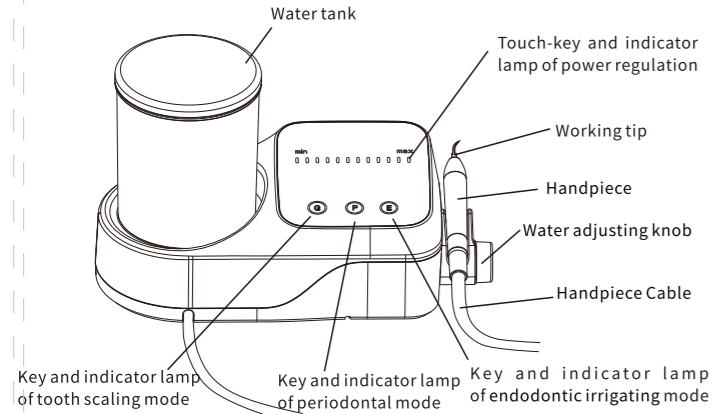

Figure 1 Main Unit Front Schematic Diagram

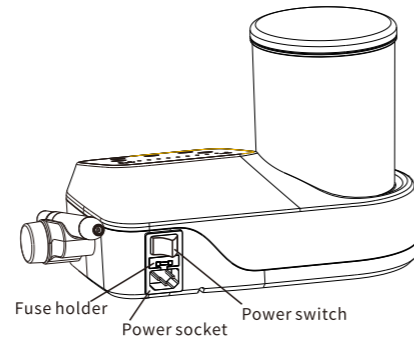

Figure 2 Main Unit Rear Schematic Diagram

### 2.2. Schematic Diagram of Connection between Foot Switch and Main Unit

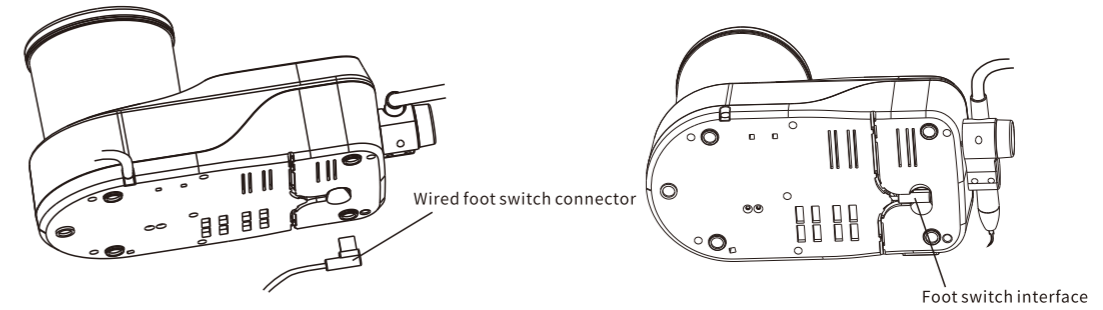

Figure 3 Schematic Diagram of Connection between Wired Foot Switch and Main Unit

Insert the USB connector of the foot switch into its corresponded interface at the bottom of the main unit according to the drawing position, and clip it into the front or rear wire slot as required by the user.

### 2.3. Water Tank Installation Schematic Diagram

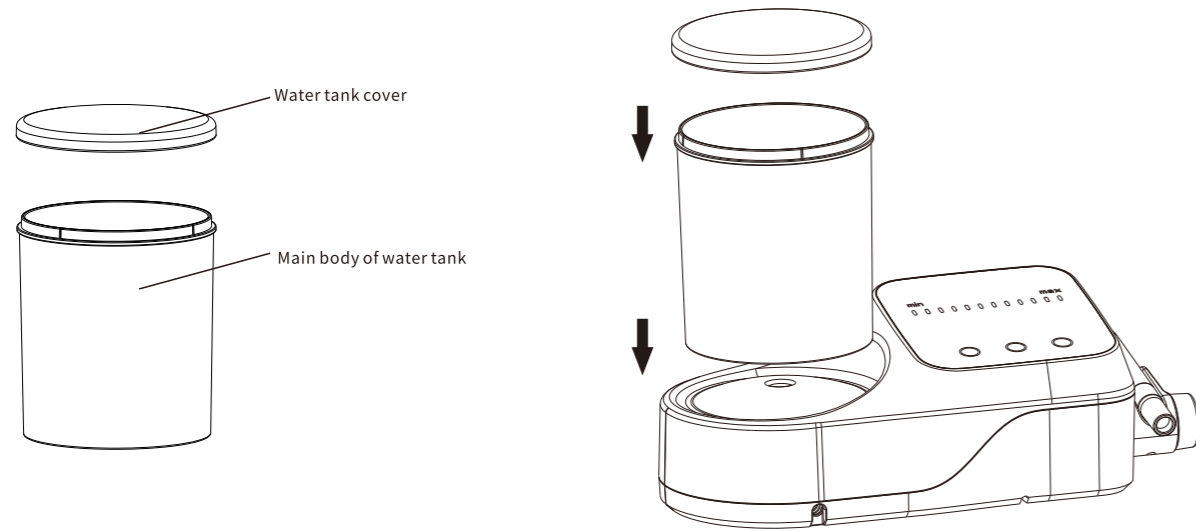

Figure 4 Water Tank Installation Schematic Diagram

### 2.4. Detachable Handpiece Installation and Connection Schematic Diagram

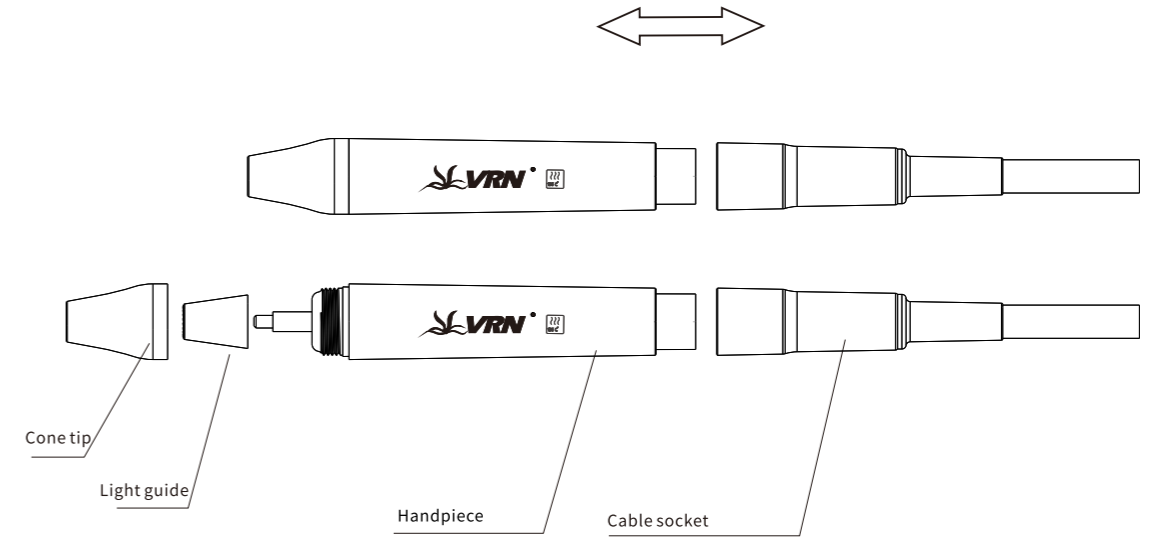

Figure 5 Detachable Handpiece Installation and Connection Schematic Diagram

## 2.5. Assemble and Disassemble Schematic Diagram of Working Tip

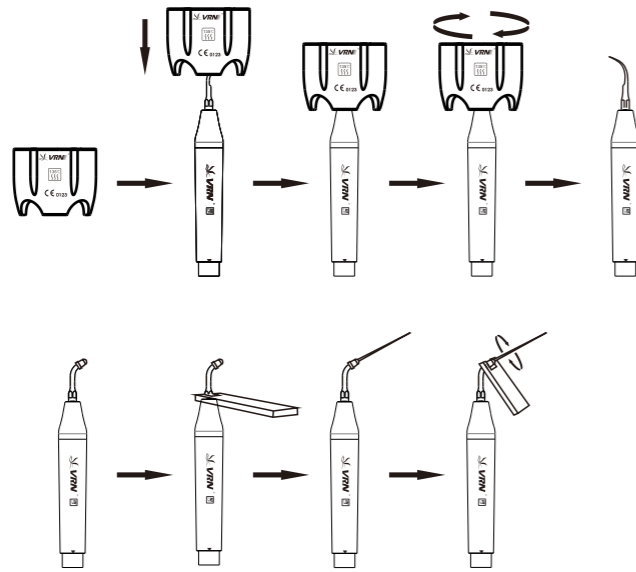

Figure 6 Assemble and Disassemble Schematic Diagram of Working Tip

## 2.6. Wireless foot switch matching

- 1) In case the equipment is electrified, long press the three keys of “G” ” P” “E” until their power indicators light up, then release the three keys.
- 2) Ensure the foot is depressed, then install two sets of size AA battery (it shall be operated when the Weirun logo lighting up).
- 3) Release the foot switch, wait for 30 seconds or restart, and the wireless foot switch can control the instrument;

## 3. Product function and use

### 3.1. Operating instructions for the use of the main components of the detachable handpiece

Cone tip: it is available to unscrew the cone tip, the user can periodically take it out and clean the main rod with alcohol.

Light guide: it can be cleaned with alcohol.

Handle: An important part of the instrument, which can be sterilized under high temperature and high pressure.

Cable socket: connect the handpiece to the water-way and circuit of main unit.



Note: when connecting the handpiece to the cable socket, please keep them dry.

### 3.2. Operating instructions of torque wrench

By employing special structure design, this torque wrench could not only effectively install and remove the working tip, but also protect the user's hands during working. Operation Steps (See Figure 6):

- 1) Insert the working tip into in the torque wrench.
- 2) Install the working tip: hold the handpiece tightly, then use the torque wrench to screw the working tip by clockwise direction until the work tip is no longer rotated, and the installation of the working tip is completed.
- 3) Remove the working tip: hold the handpiece tightly, then use the torque wrench to unscrew the working tip by counter-clockwise direction, and the working tip is removed.
- 4) Please disinfect and sterilize the torque wrench after use.
- 5) After sterilization, the surface temperature of the torque wrench is very high, it can be used again only after the torque wrench is cooled, so as to avoid scalding.
- 6) When the torque wrench is not in use, please place it in a ventilated and dry place and keep it clean.

### 3.3. Scaling, periodontal treatment function and use

- 1) First, unpack the device, and check all accessories of the instrument are complete according to the Packing List. Take out the device from the packing box, then place it on a stable and flat plane.
- 2) Turn the water volume adjusting knob to its maximum as shown in the Figure (See 3.5.1 [Note 1]).
- 3) Install the battery into the wireless foot switch, or plug the wired foot switch into its socket (See Figure 7, Figure 3).
- 4) Open the water tank, pour a proper amount of purified water into the water tank, then put its cover back, and install the water tank to the corresponded installation position of the water tank on the main frame (as shown in Fig. 4).
- 5) Use the torque wrench to fasten the working tip to the handpiece (as shown in the Fig. 6), then properly connect the handpiece to its tail socket. Before installing the handpiece, thoroughly dry the handpiece and its cable socket (as shown in Fig. 5).
- 6) Set the power switch of the main unit to OFF state, then connect the output terminal of power line to the main unit, and connect the input terminal of power supply to the mains supply (as shown in Fig. 2).

- 7) Turn on the power switch of main unit, and the "P" indicator light of tooth scaling and the first 3 power indicators will light up.
- 8) The operator shall select the operation mode of "G" and "P" according to the series of working tip. Please refer to the attached Table for the details of power used by the working tip.
- 9) When the product is working normally, the frequency is fast; under the condition of ensuring the normal water discharge of the machine, the tooth scaling only needs to be gently contacted and reciprocated at a certain speed, so that the dental calculus can be removed, and the working tip has no obvious feeling of fever; do not use excessive force locally or stay too long times when scaling teeth.
- 10) Vibration strength: adjust the magnitude of vibration strength according to actual requirements; generally, we adjust it to moderate vibration strength, or adjust the vibration strength at any time in the clinical process according to the sensitivity of the patient and the hardness of dental calculus.
- 11) Water volume adjustment: step on the foot switch to generate vibration at the working tip, rotate the water volume adjusting knob to form foot mist, so as to cool the working tip and clean the tooth surface.
- 12) Generally, the handpiece is held by the pen holding gesture.
- 13) During clinical scaling and treatment, do not make the top of the working tip come into vertical contact with the tooth, and do not apply heavy pressure, so as to avoid damaging the tooth and the working tip.
- 14) After clinical scaling and treatment, the handpiece shall be kept working for 30 seconds, the water shall be supplied during this process to clean the handpiece and working tip.
- 15) Remove the working tip and the handpiece for sterilization.



**Note: Do not pull out the handpiece when the foot switch is depressed and the product is vibrating. If the wireless foot switch is not used for a long time, please remove its battery.**

### 3.4. Endodontic irrigating function and its application

- 1) Use an endo file wrench to fix the file holder to the handpiece (as shown in Fig. 6).
- 2) Unscrew the nut of the file holder (as shown in Fig. 6).
- 3) Insert the ultrasonic endo file into the hole in front of the file holder (as shown in Fig. 6).
- 4) Use an endo file wrench to tighten the nuts of the endo file (as shown in Fig. 6).
- 5) Press the function key "E," and the indicator light of "E" is on.
- 6) When the endodontic irrigating function is selected, only the function indicator light and the first power indicator light are illuminated. When the ultrasonic endo file is slowly inserted into the patient's root canal, depress the foot switch and start the endodontic irrigating. The power of endodontic irrigating shall be adjusted according to actual requirements.



#### Attentions:

- 1) When installing the endodontic working tip, it must be firmly tightened.
- 2) When installing the nut, it must be firmly tightened.
- 3) When the endodontic irrigating is carried out to the root canal, no heavy pressure shall be applied.
- 4) Do not step on the foot switch when the ultrasonic endo file is not inserted into the root canal.
- 5) When carrying out the operation of endodontic irrigating, it is recommended that the power adjustment slowly increase from 1st gear to 3rd gear.

### 3.5. Control function and use of wireless foot switch

#### 3.5.1. Operation

- 1) Install two sets of size AA battery into the wireless foot switch according to the direction indicated by the positive and negative electrodes, install the battery cover plate and attach the waterproof rubber pad;

- 2) Place the wireless foot switch on the ground, ensure the ground is flat;
- 3) After connecting all wires of the ultrasonic scaler, turn on its power supply, and the wireless foot switch will automatically identify the code with the ultrasonic scaler.
- 4) Within 5 meters around the ultrasonic scaler, the wireless foot switch could control the starting of vibration of the ultrasonic scaler at any position.

### 3.6. Automatic water supply function and use

#### 3.6.1. Operation Steps:

- 1) Vertically pull out the water tank installed on the ultrasonic scaler.
- 2) Open the water tank, fill it with sufficient purified water, and close the water tank.
- 3) Clean the neck of the water tank, as well as interface connecting to the water tank.
- 4) Vertically insert the water tank into the interface of automatic water supply of the ultrasonic scaler.



#### Attentions:

- 1) Make sure that the air vent and water outlet are not blocked.
- 2) Check the internal gasket of the cover is in good condition, if the gasket is deformed or falls off, replace and install it in time.
- 3) Please clean the interface of the water tank before each use.
- 4) If the liquid in the water tank is lower than its lower limit level, please fill liquid in time, so as to keep the liquid path smooth.

#### 3.7. Attentions during operation:

- 1) Keep the device clean before and after use.
- 2) Do not suspend the device, or place it upside down.

- 3) Before each clinical operation, please allow the device to operate in the presence of water for 10 seconds to remove residual water from the pipeline.
- 4) During operation, the operator shall be equipped with adequate protection (e.g. goggles, face mask, etc.) to prevent him-/herself from cross-infection.
- 5) The use of the product must comply with the requirements of relevant operating procedures and relevant regulations of the medical department, and can only be used by trained doctors or technicians.
- 6) Before using this device, please disinfect the working tip and its accessories such as the wrench of working tip, etc.
- 7) Do not assemble or remove the working tip when the foot switch is pressed and the working tip vibrates.
- 8) The working tip must be tightened, and there must be water mist during operation (except for the working tip without water).
- 9) If the working tip is damaged or worn, the vibration strength will decrease, and the operator should replace the new tip in time according to the clinical conditions.
- 10) Please don't bend or polish the working tip.
- 11) It is prohibited to use unclean water source, or use normal saline instead of pure water source.
- 12) Do not pull the handpiece cable during the use of the equipment, which can avoid damage to the handpiece cable.
- 13) Do not beat or scrape the handpiece.
- 14) After using this device, turn off the power switch and pull out the power plug.
- 15) Since the Company is specialized in the production of medical devices, and only when the maintenance, repair and modification of the device are carried out by the Company or a dealer authorized by the Company, and the replaced parts are the original parts purchased from the Company and it is operated in accordance with the User Manual, the Company is responsible for the instrument safety.

- 16) The internal thread of the working tip produced by some manufacturers is rough, rusty, cracked or subject to other standards, in case the external thread of handpiece is used in combination with the aforesaid defective working tip, it is easy to damage the thread, result in the loose thread, even cause irreparable damage to the scaler, please use the original working tip.
- 17) When the operator uses different series of working tips, it is necessary to adjust the working mode of the device correspondingly to avoid breakage of the working tip.
- 18) According to the operating conditions of different working tips, it is recommended to set the power and water output in accordance with the requirements of Article 13.
- 19) Caution: the temperature of scaler tip may reach to 75.8° once water spray not supplied when continuous operated at the ambient 35°, Do not touch it until it cools down.

#### 4. Cleaning, disinfection and sterilization

##### 4.1. Disinfection of handpiece

Handle disinfection can refer to cleaning, disinfecting and sterilizing instructions. please read the instructions before disinfection, and operate according to the instructions.



##### Attentions:

- 1) **Before sterilization, use compressed air to blow and clean the cleaning liquid remaining on the handpiece.**
- 2) **Be sure to remove the working tip from the handpiece during sterilization, and do not sterilize it with other instruments.**



3) During the process of sterilization and operation, please pay your attention to the external damage of the handpiece at any time. Do not apply any protective oil to the handpiece surface.

4) Serializable components can be sterilized at least 250 times.

5) It is strictly prohibited to disinfect the handpiece in the following manner:

- Put the handpiece in the solution for stewing.
- Immerse the handpiece with iodine, alcohol, glutaraldehyde and other disinfectants.
- Put the handpiece in oven or microwave oven for high temperature baking.

#### 4.2. Disinfection of working tip

working tip disinfection can refer to cleaning, disinfecting and sterilizing instructions, please read the instructions before disinfection, and operate according to the instructions

#### 4.3. Disinfection of torque wrench and endodontic wrench

torque wrench and endodontic wrench disinfection can refer to cleaning, disinfecting and sterilizing instructions, please read the instructions before disinfection, and operate according to the instructions



#### Attentions:

**The Company shall not be responsible for any direct or indirect damage to the torque wrench and the endodontic wrench caused by the improper use mentioned above.**

#### 4.4. Cleaning of working tip, torque wrench and endodontic wrench

It is available to clean the working tip, torque wrench and endodontic wrench by an ultrasonic cleaning machine.

## 5. Troubleshooting

### 5.1. Trouble analysis and troubleshooting

Trouble	Possible causes	Troubleshooting
After stepping on the foot switch, the working tip does not vibrate, and no water flows out.	Poor connection of power plug	Correctly connect the power plug
	Poor connection of foot switch (wired)	Correctly connect the plug of foot switch
	Fuse in the power supply is broken	Contact the local dealer or our company.
	The battery of foot switch runs out	Replace the battery
	Foot switch control failure	Re-code (please refer to the code of wireless foot switch in 2.7)
After stepping on the foot switch, the working tip does not vibrate, but the water flows out.	Loosened working tip	Tighten the working tip
	The connection plug between the tail line and circuit board is disconnected.	Contact the local dealer or our company.
	Handpiece failure	Pull out the handpiece and send it back to service.
	Trouble occurs to the tail line	Contact the local dealer or our company.

Trouble	Possible causes	Troubleshooting
After stepping on the foot switch, the working tip vibrates, but no water mist forms.	The water adjusting knob is not turned on.	Turn on the water adjusting knob [Note 1]
	Impurities in the solenoid valve	Remove the solenoid valve for cleaning, or contact the local dealer or our company.
The water still flows out after turning off the device.	Solenoid valve failure	Contact the local dealer or our company.
Handpiece heating	Too small opening of the water adjusting knob	Turn on the water adjusting knob[Note 1]
Too small water outlet	Too small opening of the water adjusting knob	Turn on the water adjusting knob[Note 1]
	The water path is blocked	Use the three-way syringe to unblock the water path
The vibration of working tip	Loosened working tip	Tighten the working tip
	The working tip is loosened due to vibration.	Tighten the working tip
	The joint between handpiece and cable socket is not dry.	Dry the joint between handpiece and cable with hot air.

Trouble	Possible causes	Troubleshooting
	Working tip damage [Note 2]	Replace the working tip
Water leakage at the joint between handpiece and cable socket.	Waterproof O-ring damaged	Replace the waterproof O-ring
The ultrasonic endo file fails to vibrate	The clamp nut is loosened.	Tighten the nut
	Damaged endo file holder	Replace the endo file holder
Abnormal noise of endo file holder	The clamp nut is loosened.	Tighten the nut
No water flows out from the handpiece	The fluid path is filled with air.	Turn the water regulating valve to the maximum, and re-insert the water tank of automatic water supply.
LED light fails to light up	Poor contact	Check the circuit



**Note: If the failure has not been solved, please contact the local dealer or the Company.**

Note

【Note 1】

According to the prompts indicated by the icon, rotate the water amount adjusting knob until it can not be rotated, the water amount is minimum at this time, otherwise, it is the maximum position.

【Note 2】

In the case of ensuring that the working tip has been tightened and has been sprayed with water mist, the working tip is deemed to have been damaged by the following phenomena:

- 1)The vibrating strength and water atomization degree of the working tip are obviously weakened.
- 2)Abnormal noise of “buzzing” is sound as the working tip works.

## 6.Storage, maintenance, transportation

### 6.1.Storage, maintenance

- This product shall be carefully placed at the location where is far away from the hypo-center, and shall be installed at a cool, dry, and ventilated place.
- When storing, do not put it together with toxic, corrosive, inflammable and explosive articles.
- In case the product is not used for a long time, it should be electrified once a month, and each time lasts for 5 minutes.
- The product shall be stored at the location where temperature is within the range of -20 °C ~ 55 °C, the relative humidity is within the range of 0% ~ 90%, and the atmospheric pressure is within the range of 70 kPa ~ 106 kPa.

### 6.2.Transportation

- During transportation, it shall not be packed with dangerous goods.
- During transportation, excessive shock and vibration shall be prevented, and it shall be carefully placed, do not place it upside down.
- Protect the product from direct sunlight, rain, or snow during transportation.

## 7.Product List

No.	Name	Remarks
1	Product host	Repairable
2	Handpiece	Accessories
3	Tips	Accessories
4	Torque wrench	
5	Endo file wrench	
6	Endo file tip	Accessories





















No.	Name	Remarks
7	Water adjusting knob	
8	Connector of liquid path	
9	Sterilization box	
10	Power line	
11	Water bottle	Removable
12	Wireless foot switch	Repairable/Removable
13	Wired foot switch	Repairable/Removable
14	Main software	sine_wave_STM32codeV1.000









Note: The specifications of spare parts of the ultrasonic scaler are not listed in detail in this manual, for details, please refer to the data and packing list come with the product.

### 8. After-sales service

Since the date of sale, the warranty of this instrument is effective with its warranty card, and the Company is responsible for life-long maintenance. For the non-repairable damage caused by the maintenance of any non-designated and dedicated maintenance personnel is not covered by the free warranty.

### 9. Graphic Sign

	Registered tradem		Warning		Earth (ground)		B type applica		Recycling mark
	Specified steriliz		Manufacturer		Refer to		S/N		To be protected from
	Temperature limit		Atmospheric pressure		Fragile, handle with		Humidity limit		Production date
	Term of validity		Upward		medical device		Foot switch		Fuse

	OFF (Main)		ON (Main)		Water amount knob		Water amount adjust		IP Protection grade
Min	Minimum power	Max	Maximum power		Do not roll		Limit of stackin		size AA battery

## 10. Environmental Protection

Part Name	Toxic and hazardous substances or elements					
	Pb	Hg	Cd	Cr6+	PBB	PBDE
Main frame	<input type="radio"/>	<input type="radio"/>	<input type="radio"/>	<input type="radio"/>	<input type="radio"/>	<input type="radio"/>
Handpiece	<input type="radio"/>	<input type="radio"/>	<input type="radio"/>	<input type="radio"/>	<input type="radio"/>	<input type="radio"/>
Working tip	<input type="radio"/>	<input type="radio"/>	<input type="radio"/>	<input type="radio"/>	<input type="radio"/>	<input type="radio"/>
Foot switch	<input type="radio"/>	<input type="radio"/>	<input type="radio"/>	<input type="radio"/>	<input type="radio"/>	<input type="radio"/>
Mechanical elements, including screws, nuts, washers, etc	<input type="radio"/>	<input type="radio"/>	<input type="radio"/>	<input type="radio"/>	<input type="radio"/>	<input type="radio"/>

O: It indicates that the concentration of the toxic and hazardous substances in all homogeneous materials of the component is below the limit specified in SJ / T-11363-2006 Requirements for concentration limits for certain hazardous substances in electronic information products.

X: It indicates that the concentration of the toxic and hazardous substance in at least one homogeneous material of the component exceeds the limit specified in SJ / T-11363-2006.

(This product meets the environmental protection requirements of EU RoHS: at present, there is no proven technology in the world to replace or reduce the lead concentration in electronic ceramics, optical glass, steel and copper alloy.)

According to the terms and conditions stipulated in the Measures for the Administration of the Restricted Use of the Hazardous Substances Contained in Electrical and Electronic Products, Regulation on the Administration of the Recovery and Disposal of Waste Electrical and Electronic Products, and other relevant standards, please observe the precautions for safety and use of the product, and recycle or dispose the product in an appropriate way according to local laws and regulations.

## 11. Manufacturer's rights

The Company reserves the right to modify the design, technology, accessories, description and packing list of the products without prior notice at any time. In case of any inconformity, the actual product shall prevail.

## 12. Electromagnetic compatibility (EMC)



### Attentions:

The ME EQUIPMENT or ME SYSTEM is suitable for hospital or professional dental clinic environments.

Warning: Don't near active HF surgical equipment and the RF shielded room of an ME system for magnetic resonance imaging, where the intensity of EM disturbances is high.

Warning: Use of this equipment adjacent to or stacked with other equipment should be avoided because it could result in improper operation. If such use is necessary, this equipment and the other equipment should be observed to verify that they are operating normally.

Warning: Use of accessories, transducers and cables other than those specified or provided by the manufacturer of this equipment could result in increased electromagnetic emissions or decreased electromagnetic immunity of this equipment and result in improper operation.”

Warning: Portable RF communications equipment (including peripherals such as antenna cables and external antennas) should be used no closer than 30 cm (12 inches) to any part of the equipment, including cables specified by the manufacturer. Otherwise, degradation of the performance of this equipment could result.

#### 12.1. Requirements for cable installation

Cable name	Cable type	Cable length
Power input line	Unshielded parallel lines	1.2m
Input line of foot switch	Unshielded parallel lines	2.5m
Handpiece Cable	Unshielded parallel lines	2m

#### 12.2. Key components of electromagnetic compatibility (EMC)

The key components of electromagnetic compatibility of the product are the main-board chip, touch-panel chip, transformer, and diaphragm pump, in the case of using or replacing non-original accessories, cables and transducers of, it may result in obvious decrease of emission and immunity of the electromagnetic compatibility. Do not replace machine parts at random.

12.3. Table 1

Guidance and manufacturer's declaration - electromagnetic emissions		
The VRN-Q5 ultrasonic scaler is expected to be used in the electromagnetic environment specified below. The purchaser or user shall ensure that it is used in such electromagnetic environment.		
Emission test	Conformity	Electromagnetic environment - Guideline
RF emissions CISPR 11	Group 1	The VRN-Q5 ultrasonic scaler only uses RF energy for its internal functions. Therefore, its radio frequency is low, and the possibility of interference to nearby electronic devices is small.
RF emissions CISPR 11	Class B	The VRN-Q5 ultrasonic scaler is suitable for use in all installations, including household installations and the public low voltage supply grid directly connected to the home.
Harmonic emissions IEC 61000-3-2	Class A	
Voltage fluctuations/ flicker emissions IEC 61000-3-3	Comply	

12.4. Table 2

Guidance and manufacturer' s declaration - electromagnetic Immunity			
The VRN-Q5 ultrasonic scaler is expected to be used in the electromagnetic environment specified below. The purchaser or user shall ensure that it is used in such electromagnetic environment.			
Immunity test	IEC 60601 test level	Satisfy	Electromagnetic environment - Guideline
Electrostatic discharge (ESD) IEC 61000-4-2	±8 kV contact ±2 kV, ±4 kV, ±8 kV, ±15 kV air	±8 kV contact ±2 kV, ±4 kV, ±8 kV, ±15 kV air	The ground shall be wood, concrete or tile; if the ground is covered with synthetic material, the relative humidity shall be at least 30%.
Electrical fast transient/burst IEC 61000-4-4	±2 kV for power supply lines ±1 kV signal input/output 100 kHz repetition frequency	±2 kV for power supply lines Not Applicable 100 kHz repetition frequency	The power supply from the grid shall have the quality to be used in hospital environment.
Surge IEC 61000-4-5	±0.5 kV, ±1 kV differential mode ±0.5 kV, ±1 kV, ±2 kV common mode	±0.5 kV, ±1 kV differential mode ±0.5 kV, ±1 kV, ±2 kV common mode	The power supply from the grid shall have the quality to be used in hospital environment.

Voltage dips, short interruptions and voltage variations on power supply input lines IEC 61000-4-11	0 % UT; 0,5 cycle. At 0°, 45°, 90°, 135°, 180°, 225°, 270° and 315°. 0 % UT; 1 cycle and 70 % UT; 25/30 cycles; Single phase: at 0°. 0 % UT; 250/300 cycle	0 % UT; 0,5 cycle. At 0°, 45°, 90°, 135°, 180°, 225°, 270° and 315°. 0 % UT; 1 cycle and 70 % UT; 25/30 cycles; Single phase: at 0°. 0 % UT; 250/300 cycle	The power supply from the grid shall have the quality to be used in hospital environment. If the user of the VRN-Q5 ultrasonic scaler needs to operate continuously during power failure, it is recommended that the VRN-Q5 ultrasonic scaler be powered by an uninterruptible power supply (UPS) or the battery.
Power frequency magnetic field IEC 61000-4-8	30 A/m 50Hz/60Hz	30 A/m 50Hz/60Hz	The PFMF shall have the PFMF level characteristics of a typical place in hospital environment.
Conducted RF IEC61000-4-6	3 V 0,15 MHz – 80 MHz 6 V in ISM bands between 0,15 MHz and 80 MHz 80 % AM at 1 kHz	3 V 0,15 MHz – 80 MHz 6 V in ISM bands between 0,15 MHz and 80 MHz 80 % AM at 1 kHz	
Conducted RF IEC61000-4-6	3 V/m 80 MHz – 2,7 GHz 80 % AM at 1 kHz	3 V/m 80 MHz – 2,7 GHz 80 % AM at 1 kHz	
NOTE UT is the a.c. mians voltage prior to application of the test level.			



12.5. Table 3

Guidance and manufacturer' s declaration - electromagnetic Immunity							
The VRN-Q5 ultrasonic scaler is expected to be used in the electromagnetic environment specified below. The purchaser or user shall ensure that it is used in such electromagnetic environment.							
	Test Frequency (MHz)	Band (MHz)	Service	Modulation	Modulation (W)	Distance (m)	IMMUNITY TEST LEVEL (V/m)
Radiated RF IEC61000-4-3 (Test specifications for ENCLOSURE PORT IMMUNITY to RF wireless communication s equipment)	385	380-390	TETRA 400	Pulse modulation 18 Hz	1,8	0.3	27
	450	430-470	GMRS 460, FRS 460	FM ± 5 kHz deviation 1 kHz sine	2	0.3	28
	710	704-787	LTE Band 13, 17	Pulse modulation 217 Hz	0,2	0.3	9
	745						
	780						
	810	800-960	GSM 800/900, TETRA 800, iDEN 820, CDMA 850, LTE Band 5	Pulse modulation 18 Hz	2	0.3	28
	870						
	930						
	1720	1700-1990	GSM 1800; CDMA 1900; GSM 1900; DECT; LTE Band 1, 3, 4, 25; UMTS	Pulse modulation 217 Hz	2	0.3	28
	1845						
1970							

	2450	2400-2570	Bluetooth, WLAN, 802.11 b/g/n, RFID 2450, LTE Band 7	Pulse modulation 217 Hz	2	0.3	28
	5240	5100-5800	WLAN 802.11 a/n	Pulse modulation 217 Hz	2	0.3	9
	5500						
	5785						

12.6. Recommended isolation distance between portable and mobile RF communication devices and VRN-Q5 ultrasonic scaler

Recommended isolation distance between portable and mobile RF communication devices and VRN-Q5 ultrasonic scaler

The VRN-Q5 ultrasonic scaler is expected to be used in the electromagnetic environment where radiation RF disturbances are controlled. According to the maximum output power of the communication device, the purchaser or user may prevent electromagnetic interference by maintaining the minimum distance (as recommended below) between the portable and mobile RF communication device (transmitter) and the VRN-Q5 ultrasonic scaler.

Rated maximum output power/W of transmitter	Isolation distance/m corresponding to different frequencies of the transmitter		
	150 kHz~80 MHz $d = \left[ \frac{3.5}{V1} \right] \sqrt{P}$	80 Mhz~800 MHz $d = \left[ \frac{3.5}{E1} \right] \sqrt{P}$	800 MHz~2.5 GHz $d = \left[ \frac{7}{E1} \right] \sqrt{P}$
0.01	0.12	0.12	0.23
0.1	0.38	0.38	0.73
1	1.2	1.2	2.3

10	3.8	3.8	7.3
100	12	12	23

For the rated maximum output power of transmitter not listed (if any) in above Table, the recommended isolation distance d, in meters (m), can be determined by using the formula in the corresponding transmitter frequency column, where P is the maximum output power of transmitter provided by the transmitter manufacturer, the unit shall be Watts (W).

Note 1: formulas for higher frequency range are used at frequencies of 80MHz and 800 MHz.

Note 2: these guidelines may not be appropriate for all situations, the electromagnetic transmission is affected by the absorption and emission of buildings, objects and human bodies.

The VRN-Q5 ultrasonic scaler has passed the test according to the requirements of YY 0505-2012 / IEC 60601-1-2: 2004; however, it does not guarantee in any way that it is not affected by electromagnetic interference.

The VRN-Q5 ultrasonic scaler shall not be used in high electromagnetic environment.

### 13.Attached table: Power Table of Working Tip

Scaling		
Model	Gear	Water amount
G1	1-10(G)	Yes
G3	1-10(G)	Yes
G4	1-6(G)	Yes

Periodontal			P12R	1-6(P)	Yes
Model	Gear	Water amount	P16	1-6(P)	Yes
P1	1-10(P)	Yes	IM1	1-4(P)	Yes
P11	1-6(P)	Yes			
P12	1-6(P)	Yes			
P12L	1-6(P)	Yes			

Root canal		
Model	Gear	Water amount
E1	1-3(E)	Yes

### Electrical schematic diagram

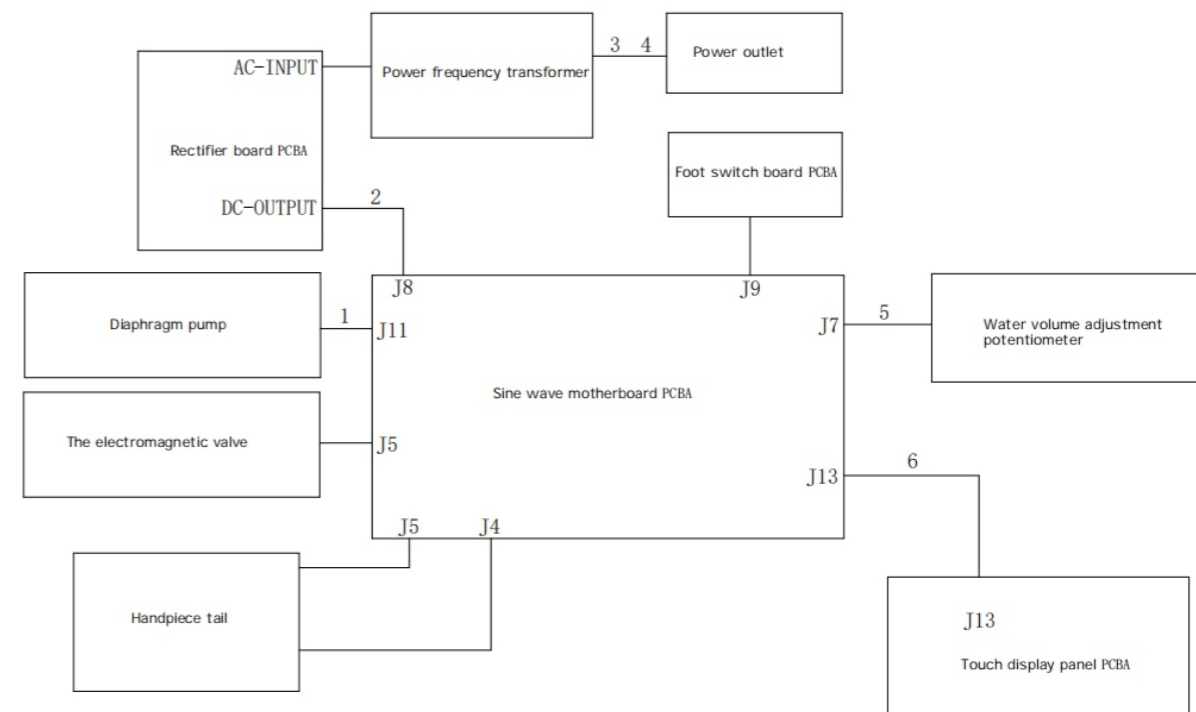

The control signal is given to the main control board through wired or 2.4 GHz wireless communication. The main control board of the product can control the water pump, solenoid valve and handle work.